

EVERWIN

FCN90 (B) / FCN90LB / SCN90L / PN90

Pneumatic Coil Nailer



**OPERATIONS and MAINTENANCE MANUAL
CE DECLARATION OF CONFORMITY**

⚠ WARNING:

BEFORE OPERATING THIS TOOL, ALL OPERATORS SHOULD READ AND STUDY THIS MANUAL TO UNDERSTAND AND FOLLOW THE SAFETY WARNINGS AND INSTRUCTIONS. KEEP THESE INSTRUCTIONS WITH THE TOOL FOR FUTURE REFERENCE.

INTRODUCTION

The tool is designed for high speed, high volume nailing. These tools will deliver efficient, dependable service when used correctly and with care. As with any fine power tool, the manufacturer's instructions must be followed for best performance. Please study this manual before operating the tool and understand the safety warnings and cautions. The instructions on installation, operation and maintenance should be read carefully, and the manuals kept for reference.

NOTE: Additional safety measures may be required because of your particular application of the tool. Contact your EVERWIN representative or distributor with any questions concerning the tool and its use. Everwin Pneumatic Corp., Taichung City, Taiwan 41353.

INDEX

1-Year Limited Warranty -----	3
CE Declaration of Conformity -----	4
Safety Instructions -----	5
Specifications and Technical Data -----	6
Operating Pressure, Setting Correct Pressure -----	6
Operation -----	7
Air Supply and Connections: Fittings, Hoses, Filters, Air Consumption, Regulators, Supply source -----	8
Lubrication -----	9
Nail Loading -----	9
Tool Operation -----	10
Tool Operation Check -----	13
Maintaining the Pneumatic Tool -----	14
Driver Maintenance Instructions -----	14
Trouble Shooting / Repairs -----	14

1-YEAR LIMITED WARRANTY

(U.S. and Canada Only)

EVERWIN products are designed and manufactured to the highest standards of both material and workmanship. EVERWIN warrants to the original retail purchaser that the product purchased is free from defect in material and workmanship and agrees to repair or replace at EVERWIN 's option any defective EVERWIN pneumatic stapler or nailer for a period of one year, subject to the exclusions and limitations described hereunder. To honor a warranty claim, EVERWIN and its authorized distributor need proof of purchase, may request the damaged tool, serial number of the damaged tool, photos/videos of the defect for test and evaluation to determine whether the damaged tool is within warranty conditions; your cooperation in this regard will be appreciated to expedite the claim process and to help with EVERWIN's continuous efforts in quality improvement.

THIS WARRANTY IS IN LIEU OF ALL OTHER WARRANTIES, EXPRESS OR IMPLIED, INCLUDING BUT NOT LIMITED TO THE IMPLIED WARRANTIES OF MERCHANTABILITY OR FITNESS FOR A PARTICULAR PURPOSE. EVERWIN SHALL NOT BE LIABLE FOR ANY INCIDENTAL OR CONSEQUENTIAL DAMAGES.

WARRANTY EXCLUSIONS

The following warranty exclusions apply:

- a. Normal wear parts are not covered by this warranty. Examples of such parts include, o-rings and seals, driver blades, bumpers, pistons and piston rings.
- b. Failure due to normal wear, neglect, abuse, misuse, misapplication, accidents, over-pressure usage, improper storage, shipping damages, improper maintenance, operation not within the operation manual's specification etc. are not covered by this warranty.
- c. Labor charges, loss, repairs from improper maintenance and/or usage of non-EVERWIN parts are not covered by this warranty.
- d. This warranty does not apply to production or industrial tools as defined by EVERWIN; industrial or production tools are covered on the following grounds.

GROUND S FOR INDUSTRIAL / PRODUCTION TOOL COVERAGE

For high production industrial tools, coverage is limited to 90 days due to high volume usage; warranty on production tools cannot be guaranteed due to unpredictable circumstances. Tools are subjected to abuse such as hammering or usage of adjustment tools, especially true in loan tool programs. Upon receiving a report, EVERWIN and its authorized distributor may request the damaged tool, serial number of the damaged tool (as a gauge for the tool's age) and photos/videos of the defect for test and evaluation to find root causes. EVERWIN's analyst will judge the issuance of defective parts and will replace at no charge if evaluation results show that the root cause is defect in material and/or workmanship.

Note: all warranty services will be carried out by EVERWIN authorized repair centers, please contact sales@everwinpneumatic.com for the location most convenient for you.

CE DECLARATION OF CONFORMITY

CE Declaration of conformity EVERWIN PNEUMATIC CORP. declares that the product as described in attached documentation is in conformity with the Machinery Directive 2006/42/EC and the European standard EN 792-13 .	ENGLISH
CE Dichiarazione di conformità EVERWIN PNEUMATIC CORP. dichiara, assumendo la piena responsabilità, che questa fissatrice è conforme alla Direttive Europee 2006/42/EC e alla norma armonizzata EN 792-13 .	ITALIANO
CE Konformitätserklärung EVERWIN PNEUMATIC CORP. erklärt hiermit in alleiniger Verantwortung das dieses Gerät übereinstimmt mit den Europäischen Richtlinien 2006/42/EC und den Europäischen Norm EN 792-13 .	DEUTSCH
CE Déclaration de conformité EVERWIN PNEUMATIC CORP. déclare et prend sur soi toute la responsabilité de cette déclaration, que le produit est en conformité avec les Directives Européennes 2006/42/EC et avec la norme harmonisée EN 792-13 .	FRANCAIS
CE konformiteitsverklaring EVERWIN PNEUMATIC CORP. verklaart hierbij onder eigen verant woordelijkheid dat deze machine in overeenstemming is met de Europese Richtlijnen 2006/42/EC en de Europese norm EN 792-13 .	NEDERLANDS
CE Declaracion de conformidad EVERWIN PNEUMATIC CORP. declaramos bajo nuestra sola responsabilidad que este producto esta en conformidad con las Directivas Europeas 2006/42/EC y con la normativa EN 792-13 .	ESPAGNOL
Overensstemmelseserklæring / CE Deklaration EVERWIN PNEUMATIC CORP. erklærer herved, at produktet er i overensstemmelse med nedenstående normer eller normative dokumenter 2006/42/EC i henhold til bestemmelserne i EU's direktiv EN 792-13 .	DANSK
Överstämmeelseförklaring / CE Deklaration EVERWIN PNEUMATIC CORP. förklarar härmed att produkten överensstämmer med följande normer och direktiv 2006/42/EC och SS-EN 792-13 .	SVENSK
SAMSVARSERKLÆRING / CE Deklaration EVERWIN PNEUMATIC CORP. erklærer herved att produktet er i samsvar med følgende normer og direktiv 2006/42 EC og NS-EN 792-13 .	NORSK
Todistus CE standardinmukaisuudesta EVERWIN PNEUMATIC CORP. vakuuttaa täten tuotteen vastaavan seuraavla standardeja ja direktiivejä: 2006/42/EC ja EN 792-13 .	FINSK
Deklaracja zgodności CE EVERWIN PNEUMATIC CORP. oświadcza, że produkty opisane w załączonej dokumentacji spełniają wymogi Dyrektywy Maszynowej 2006/42/EC oraz Europejskiej normy EN 792-13 .	POLSKIE

Machine Type: FCN90, FCN90L, SCN90L, PN90, PN90-TS, PN90PAL, FCN90B, FCN90LB

Machine Name: Pneumatic Fastener Driving Tool

Place of Issue: No. 7, Wugong 7th Rd., Wufeng Dist., Taichung City 41353, Taiwan.

Date of Issue: Mar. 19, 2019

Signature of Issuer:



Hung-Ming Chuang
General Manager

SAFETY INSTRUCTIONS

⚠WARNING:

TO AVOID SEVERE PERSONAL INJURY OR PROPERTY DAMAGE



BEFORE OPERATING THIS TOOL, ALL OPERATORS SHOULD READ AND STUDY THIS MANUAL TO UNDERSTAND AND FOLLOW THE SAFETY WARNINGS AND INSTRUCTIONS. FAILURE TO FOLLOW WARNINGS COULD RESULT IN DEATH OR SERIOUS INJURY. KEEP THESE INSTRUCTIONS WITH THE TOOL FOR FUTURE REFERENCE.

SAFETY INSTRUCTIONS:



EYE PROTECTION which conforms to ANSI/ CE specifications and provides protection against flying particles both from the FRONT and SIDE should ALWAYS be worn by the operator and others in the work area when connecting to air supply, loading, operating or servicing this tool. Eye protection is required to guard against flying fasteners and debris, which could cause severe eye injury.

The employer and/or user must ensure that proper eye protection is worn. Eye protection equipment must conform to the requirements of the ANSI Z87.1 and 89/686/EEC, and provide both frontal and side protection. NOTE: Non-side shielded spectacles and face shields alone do not provide adequate protection.



CAUTION: Additional Safety Protection will be required in some environments. For example, the working area may include exposure to noise level which can lead to hearing damage. The employer and user must ensure that any necessary hearing protection is provided and used by the operator and others in the work area. Some environments will require the use of head protection equipment. When required, the employer and user must ensure that head protection conforming to ANSI Z89.1/ CE is used.



AIR SUPPLY AND CONNECTIONS

Do not use oxygen, combustible gases, or bottled gases as a power source for this tool as tool may explode possibly causing injury.

Do not use supply sources which can potentially exceed 200 PSI (14 kg/cm²) as tool may burst, possibly causing injury.

⚠WARNING:

The connector on the tool must not hold pressure when air supply is disconnected. If a wrong fitting is used, the tool can remain charged with air after disconnecting and thus will be able to drive a fastener even after the air line is disconnected, possibly causing injury.



Do not pull trigger or depress contact arm while connected to the air supply as the tool may cycle, possibly causing injury.

Always disconnect air supply: 1.) Before making adjustments; 2.) When servicing the tool; 3.) When clearing a jam; 4.) When tool is not in use; 5.) When moving to a different work area, as accidental actuation may occur, possibly causing injury.



NAIL LOADING

When loading tool: 1.) Never place a hand or any part of body in fastener discharge area of tool; 2.) Never point tool at anyone; 3.) Do not pull the trigger or depress the trip as accidental actuation may occur, possibly causing injury.

⚠WARNING:

OPERATION

Always handle the tool with care: 1.) Never engage in horseplay; 2.) Never pull the trigger unless nose is directed toward the work; 3.) Keep others a safe distance from the tool while tool is in operation as accidental actuation may occur, possibly causing injury.

The operator must not hold the trigger pulled on contact arm tools except during fastening operation as serious injury could result if the trip accidentally contacts someone or something, causing the tool to cycle.



Keep hands and body away from the discharge area of the tool. A contact arm tool may bounce from the recoil of driving a fastener and an unwanted second fastener may be driven, possibly causing injury.

Check operation of the contact-arm mechanism frequently. Do not use the tool if the arm is not working correctly as accidental driving of a fastener may result. Do not interfere with the proper operation of the contact-arm mechanism.

Do not drive fasteners on top of other fasteners or with the tool at an overly steep angle as this may cause deflection of fasteners which could cause injury.

Do not drive fasteners close to the edge of the work piece as the wood may split, allowing the fastener to be deflected possibly causing injury.

⚠WARNING:

MAINTAINING THE TOOL

When working on air tools, note the warnings in this manual and use extra care when evaluating problem tools.

SPECIFICATIONS AND TECHNICAL DATA

SPECIFICATIONS

MODEL	FCN90(B)	FCN90L(B)	SCN90L	PN90
HEIGHT	13.2" (335mm)	14.3" (364mm)	14.3" (364mm)	13.8" (350mm)
WIDTH	5.2" (131 mm)	5.1" (130mm)	5.1" (130mm)	5.2" (131mm)
LENGTH	11.9" (302 mm)	12.2" (311mm)	12.2" (311mm)	11.9" (302mm)
WEIGHT	7.7 lbs. (3.5 kg)	6.6 lbs. (3.0 kg)	6.7 lbs. (3.05 kg)	8.2 lbs. (3.7 kg)
LOADING CAPACITY	150~300	150~300	150~300	150~300
AIR CONSUMPTION at 90 PSI (6 bar) pres.	4.2 cfm (2.0 liter/second)	3.4 cfm (1.6 liter/second)	3.4 cfm (1.6 liter/second)	4.4 cfm (2.1 liter/second)

FASTENER SPECIFICATIONS

MODEL	FCN90(B)	FCN90L(B)	SCN90L	PN90
NAIL LENGTH	2" - 3-1/2" (50 - 90 mm)	2" - 3-1/2" (50 - 90 mm)	2" - 3-1/2" (50 - 90 mm)	2" - 3-1/2" (50 - 90mm)
SHANK DIA.	.099" - .148" (2.5 - 3.8 mm)	.099" - .148" (2.5 - 3.8mm)	.099" - .148" (2.5 - 3.8mm)	.099" - .148" (2.5 - 3.8 mm)
HEAD DIA.	.256" - .303" (6.5 - 7.7 mm)	.256" - .303" (6.5 - 7.7 mm)	.256" - .303" (6.5 - 7.7 mm)	.256" - .303" (6.5 - 7.7 mm)
SHANK TYPE	Smooth, Ring, Screw			
COLLATION	15° Wire	15° Wire / Plastic Sheet	15° Wire / Plastic Sheet	15° Wire

TOOL AIR FITTING

This tool uses a 3/8"-18 N.P.T. or 3/8"-19 P.T. male plug. The inside diameter should be .280" (7 mm) or larger. The fitting must be capable of discharging tool air pressure when disconnected from the air supply.

OPERATING PRESSURE

70 to 120 PSI (5 to 8 kg/cm²). Select the operating pressure within this range for best fastener performance. **DO NOT EXCEED THIS RECOMMENDED OPERATING PRESSURE.**

TECHNICAL DATA

AIR CONSUMPTION

Tool air consumption: FCN90(B)-4.2 cfm (2.0 liter/second), FCN90L(B)-3.4 cfm (1.6 liter/second), SCN90L-3.4 cfm (1.6 liter/sec), PN90-4.4 cfm (2.1 liter/second) of free air to operate at the rate of 100 nails per minute, at 90 PSI (6.0 kg/cm²). Take the actual rate at which the tool will be run to determine the amount of air required. For instance, if your fastener usage averages 50 nails per minute, you need 50% of the tool air consumption in running at 100 nails per minute.

NOISE

A-weighted single-event sound power level LWA, 1s: FCN90(B)-108.8, FCN90L(B)-109.3, SCN90L-109.3, PN90-108.8 dBA

A-weighted single-event emission sound pressure level at work station LpA 1s,d: FCN90(B)-109.5, FCN90L(B)-105.2, SCN90L-105.2, PN90-109.5 dBA

These values are determined and documented in accordance to EN12549.

VIBRATION

Vibration characteristic value= FCN90(B)-4.57, FCN90L(B)-3.68, SCN90L-3.68, PN90-4.57 m/s²

These values are determined and documented in accordance to ISO 8662-11.

This value is a tool-related characteristic value and does not represent the influence to the hand-arm-system when using the tool. An influence to the hand-arm-system when using the tool will, for example, depend on the gripping force, the contact pressure force, the working direction, the adjustment of mains supply and the workpiece support.

OPERATION

Refer to Operation Instructions and warnings on pages before proceeding to use this tool.

SMART TRIGGER: IDENTIFIED BY RED TRIGGER →

Available on the FCN90



CONTINUOUS BUMP FIRE OPERATION WITH SMART TRIGGER

The common operating procedure on "Contact Trip" tools is for the operator to contact the work to actuate the trip mechanism while keeping the trigger pulled, thus driving a fastener each time the work is contacted. This will allow rapid fastener placement on many jobs, such as sheathing, decking and pallet assembly. All pneumatic tools are subject to recoil when driving fasteners. The tool may bounce, releasing the trip, and if unintentionally allowed to recontact the work surface with the trigger still actuated (finger still holding trigger pulled) an unwanted second fastener will be driven. (see detailed illustration hereunder)

SINGLE SEQUENTIAL FIRE OPERATION WITH SMART TRIGGER

For single fire operation, depress the Contact Arm against the work piece and pull the Trigger. Tool cannot fire a second nail until the Trigger is released and tool can cycle. (see detailed illustration hereunder)

SMART TRIGGER SYSTEM

Ability to switch between single or bump fire modes without adjusting the tool

1. First compress the contact arm against work piece
2. Then pull the trigger

This order of motions puts the tool in **Single Sequential Fire Mode**

1. First pull the trigger
2. Then bump the contact arm against work piece

This order of motions puts the tool in **Continuous Bump Fire Mode**

The diagram shows two sequences of operations for the smart trigger system. The top sequence shows a hand compressing the contact arm against a work piece and then pulling the trigger, resulting in a single fire. The bottom sequence shows a hand pulling the trigger first and then bumping the contact arm against the work piece, resulting in continuous bump fire. The tool is shown in a side view, and the work piece is shown as a dark surface.

CONTACT TRIP: IDENTIFIED BY BLACK TRIGGER →

Available on the FCN90B, FCN90L, FCN90LB, SCN90L & PN90



The common operating procedure on "Contact Trip" tools is for the operator to contact the work to actuate the trip mechanism while keeping the trigger pulled, thus driving a fastener each time the work is contacted. This will allow

rapid fastener placement on many jobs, such as sheathing, decking and pallet assembly. All pneumatic tools are subject to recoil when driving fasteners. The tool may bounce, releasing the trip, and if unintentionally allowed to recontact the work surface with the trigger still actuated (finger still holding trigger pulled) an unwanted second fastener will be driven.

SEQUENTIAL TRIP: IDENTIFIED BY NICKEL PLATED TRIGGER

Available on the FCN90B, FCN90L, FCN90LB, SCN90L & PN90

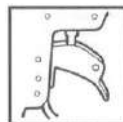

The Sequential Trip requires the operator to hold the tool against the work before pulling the trigger. This makes accurate fastener placement easier, for instance on framing, toe nailing and crating applications. The Sequential Trip allows exact fastener location without the possibility of driving a second fastener on recoil, as described under "Contact Trip". The Sequential Trip Tool has a positive safety advantage because it will not accidentally drive a fastener if the tool is contacted against the work – or anything else – while the operator is holding the trigger pulled.



If trigger system is not operating as described, do not use the tool and contact your nearest service center.

REMOTE FIRE: IDENTIFIED BY CONTROL VALVE AIR INLET

Available on the FCN90B, FCN90L, FCN90LB, SCN90L & PN90

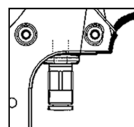

AIR SUPPLY AND CONNECTIONS



DO NOT USE OXYGEN, COMBUSTIBLE GASES, OR BOTTLED GASES AS A POWER SOURCE FOR THIS TOOL AS TOOL MAY EXPLODE, POSSIBLY CAUSING INJURY.



FITTINGS: Install a male plug on the tool which is free flowing and which will release air pressure from the tool when disconnected from the supply source.



HOSES: Air hoses should have a minimum of 150 PSI (10.6 kg/cm²) working pressure rating or 150 percent of the maximum pressure that could be produced in the air system. The supply hose should contain a fitting that will provide "quick disconnecting" from the male plug on the tool.



SUPPLY SOURCE: Use only clean, regulated compressed air as a power source for this tool. NEVER USE OXYGEN, COMBUSTIBLE GASES, OR BOTTLED GASES AS A POWER SOURCE FOR THIS TOOL AS TOOL MAY EXPLODE.



REGULATOR: A pressure regulator with an operating pressure of 0 - 125 PSI (0 - 8.79 kg/cm²) is required to control the operating pressure for safe operation of this tool. Do not connect this tool to air pressure which can potentially exceed 200 PSI (14 kg/cm²) as tool may fracture or burst, possibly causing injury.



OPERATING PRESSURE: Do not exceed recommended maximum operating pressure as tool wear will be greatly increased. The air supply must be capable of maintaining the operating pressure at the tool. Pressure drops in the air supply can reduce the tool's driving power. Refer to "TOOL SPECIFICATIONS" for setting the correct operating pressure for the tool.



FILTER: Dirt and water in the air supply are major causes of wear in pneumatic tools. A filter will help to get the best performance and minimum wear from the tool. The filter must have adequate flow capacity for the specific installation. The filter has to be kept clean to be effective in providing clean compressed air to the tool. Consult the manufacturer's instructions on proper maintenance of your filter. A dirty and/or clogged filter will cause a pressure drop which will reduce the tool's performance.

LUBRICATION

Frequent, but not excessive, lubrication is required for best performance. Air-tool oil added through the air line connection will lubricate the internal parts. Do not use detergent oil or additives as these lubricants will cause accelerated wear to the seals and bumpers in the tool, resulting in poor tool performance and frequent tool maintenance.

If no air line lubricator is used, add oil during use into the air fitting on the tool once or twice a day. Only a few drops of oil at a time is necessary. Too much oil will only collect inside the tool and will be noticeable in the exhaust cycle.

COLD WEATHER OPERATION

For cold weather operation, near and below freezing, the moisture in the air line may freeze and prevent tool operation. We recommend the use of permanent antifreeze (ethylene glycol) as a cold weather lubricant.

CAUTION:

Do not store tools in a cold-weather environment to prevent frost or ice formation on the tools operating valves and mechanisms, which could cause tool failure. Test tool without fasteners prior to operations to ensure no malfunction on the tool due to ice formation.

NOTE:

Some commercial air line drying liquids are harmful to O-Rings and seals – do not use these low temperature air dryers without checking compatibility.

NAIL LOADING

EYE PROTECTION which conforms to ANSI/ CE specifications and provides protection against flying particles both from the **FRONT** and **SIDE** should **ALWAYS** be worn by the operator and others in the work area when connecting to air supply, loading, operating or servicing this tool. Eye protection is required to guard against flying fasteners and debris, which could cause severe eye injury.

The employer and/or user must ensure that proper eye protection is worn. Eye protection equipment must conform to the requirements of the ANSI Z87.1 and 89/686/EEC, and provide both frontal and side protection. **NOTE:** Non-side shielded spectacles and face shields alone do not provide adequate protection.

⚠WARNING:



⚠WARNING:

TO PREVENT ACCIDENTAL INJURIES:

- Never place a hand or any other part of the body in nail discharge area of tool while the air supply is connected.
- Never point the tool at anyone else.
- Never engage in horseplay.
- Never pull the trigger unless nose is directed at the work.
- Always handle the tool with care.
- Do not pull the trigger or depress the trip mechanism while loading the tool.

LOADING THE TOOL:

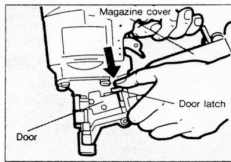

Open the magazine: Pull down door latch and swing door open. Open the magazine.

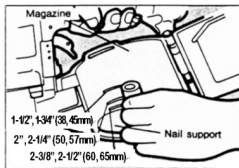

Nail length adjustment: The nail support can be moved up and down to four settings. To change setting pull up on the post and twist to the correct step. The nail support should be adjusted correctly to the position indicated in inches and millimeters inside magazine.

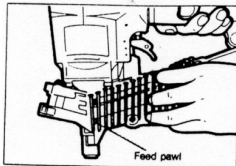

Nail loading: Place a coil of nails over the post in the magazine. Uncoil enough nails to reach the feed pawl, and place the second nail between the teeth on the feed pawl. The nail heads fit in slot on nose.

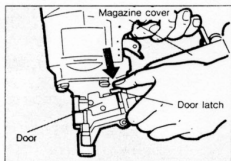

**Swing Cover Closed
Close the door:** Check that latch engages. (If it does not engage, check that the nail heads are in the slot on the nose.)

TOOL OPERATION

WARNING:



EYE PROTECTION which conforms to ANSI/ CE specifications and provides protection against flying particles both from the **FRONT** and **SIDE** should **ALWAYS** be worn by the operator and others in the work area when connecting to air supply, loading, operating or servicing this tool. Eye protection is required to guard against flying fasteners and debris, which could cause severe eye injury.

The employer and/or user must ensure that proper eye protection is worn. Eye protection equipment must conform to the requirements of the ANSI Z87.1 and 89/686/EEC, and provide both frontal and side protection. **NOTE:** Non-side shielded spectacles and face shields alone do not provide adequate protection.

BEFORE HANDLING OR OPERATING THIS TOOL:

- **READ AND UNDERSTAND THE WARNINGS CONTAINED IN THIS MANUAL.**
- **REFER TO "TOOL SPECIFICATIONS" IN THIS MANUAL TO IDENTIFY THE OPERATING SYSTEM ON YOUR TOOL.**

WARNING:

The operator must not hold the trigger on contact trip tools except during fastening operation, as serious injury could result if the trip accidentally contacts someone or something, causing the tool to cycle.

WARNING:

Keep hands and body away from the discharge area of the tool. A contact trip tool may bounce from the recoil of driving a fastener and an unwanted second fastener may be driven, possibly causing injury.

There are three available systems on the FCN90B, FCN90L, FCN90LB, SCN90L & PN90:

1. CONTACT TRIP OPERATION (RAPID FIRE):

To operate the tool in this manner, hold the tool with the contact trip pointing towards but not touching the work surface. Pull the trigger and then tap the contact trip against the work surface using a bouncing motion. Each depression of the contact trip will cause a fastener to be driven.

2. SEQUENTIAL TRIP OPERATION (SINGLE FIRE):

To operate the tool in this manner, first position the contact trip on the work surface, **WITHOUT PULLING THE TRIGGER**. Depress the contact trip until the nose touches the work surface and then pull the trigger to drive a fastener. Do not press the tool against the work with extra force. Instead, allow the tool to recoil off the work surface to avoid a second unwanted fastener. Remove your finger from the trigger after each operation

3. REMOTE FIRE:

The Remote fire model is cycle by actuation of remote valve (RCVA1) for mounted machine.

There is one available system on the FCN90:

1. SMART TRIGGER OPERATION:

CONTINUOUS BUMP FIRE OPERATION WITH SMART TRIGGER

The common operating procedure on "Contact Trip" tools is for the operator to contact the work to actuate the trip mechanism while keeping the trigger pulled, thus driving a fastener each time the work is contacted. This will allow rapid fastener placement on many jobs, such as sheathing, decking and pallet assembly. All pneumatic tools are subject to recoil when driving fasteners. The tool may bounce, releasing the trip, and if unintentionally allowed to recontact the work surface with the trigger still actuated (finger still holding trigger pulled) an unwanted second fastener will be driven.

SINGLE SEQUENTIAL FIRE OPERATION WITH SMART TRIGGER

For single fire operation, depress the Contact Arm against the work piece and pull the Trigger. Tool cannot fire a second nail until the Trigger is released and tool can cycle.

DRIVING DEPTH ADJUSTMENT DIAL (FCN90(B), FCN90LB & SCN90L)



ALWAYS discount air supply before Adjustment dial.

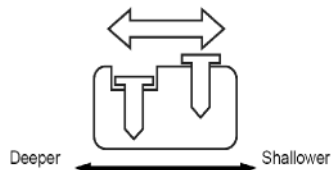
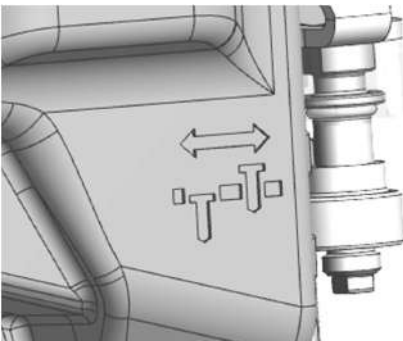

1. With air pressure set, drive nails into a representative material sample to determine if adjustment is necessary.
2. If adjustment is required, disconnect air supply.
3. Refer to the mark on the Contact Arm area for direction to turn the Adjustment dial.
4. Reconnect air supply.

TRIGGER LOCK MECHANISM (FCN90)

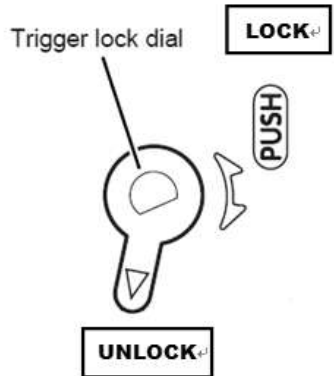
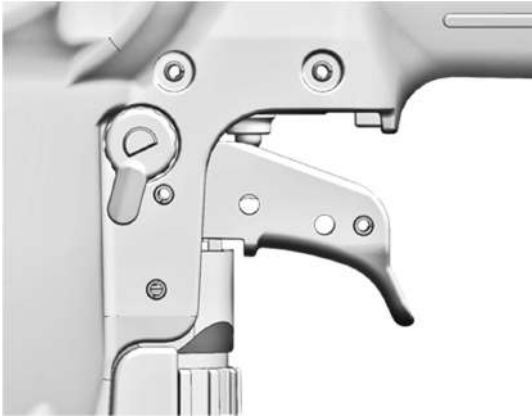

The tool is equipped with a Trigger Lock mechanism. Push and rotate the Trigger Lock Dial to the trigger free position before driving nails.

DIRECTIONAL EXHAUST COVER (FCN90LB & PN90)

WARNING: ALWAYS disconnect air supply before rotating the exhaust cover by hand.

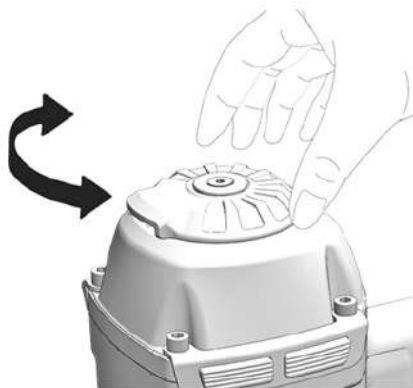

Direction of the exhaust air is changed by rotating exhaust cover by hand.

TOOL OPERATION CHECK

CAUTION: Remove all fasteners from tool before performing tool operation check.

1. CONTACT TRIP OPERATION:

- a. With finger off the trigger, press the contact trip against the work surface.
THE TOOL MUST NOT CYCLE.
- b. Hold the tool off the work surface, and pull the trigger.
THE TOOL MUST NOT CYCLE.
- c. With the tool off the work surface, pull the trigger. Press the contact trip against the work surface.
THE TOOL MUST CYCLE.
- d. Without touching the trigger, press the contact trip against the work surface, then pull the trigger.
THE TOOL MUST CYCLE.

2. SEQUENTIAL TRIP OPERATION:

- a. Press the contact trip against the work surface, without touching the trigger.
THE TOOL MUST NOT CYCLE.
- b. Hold the tool off the work surface and pull the trigger.
THE TOOL MUST NOT CYCLE.
Release the trigger. The trigger must return to the trigger stop on the frame.
- c. Pull the trigger and press the contact trip against the work surface.
THE TOOL MUST NOT CYCLE.
- d. With finger off the trigger, press the contact trip against the work surface. Pull the trigger.
THE TOOL MUST CYCLE.

IN ADDITION TO THE OTHER WARNINGS CONTAINED IN THIS MANUAL OBSERVE THE FOLLOWING FOR SAFE OPERATION

- Use the this pneumatic tool only for the purpose for which it was designed like pallet, crating, sheathing, decking applications
- Never use this tool in a manner that could cause a fastener to be directed toward the user or others in the work area.
- Do not use the tool as a hammer.
- Always carry the tool by the handle. Never carry the tool by the air hose.
- Do not carry this tool with the trigger depressed when not in use.
- Do not alter or modify this tool from the original design or function.
- Always be aware that misuse and improper handling of this tool can cause injury to yourself and others.
- Never clamp or tape the trigger or contact trip in an actuated position.
- Never leave a tool unattended with the air hose attached.
- Do not operate this tool if it does not contain a legible **WARNING LABEL**.
- Do not continue to use a tool that leaks air or does not function properly. Notify your distributor or representative if your tool continues to experience functional problems.

MAINTAINING THE PNEUMATIC TOOL

WARNING:

When working on air tools, note the warnings in this manual and use extra care evaluating problem tools. Disconnect air supply and empty the magazine when inspecting or maintaining the tool.

REPLACEMENT PARTS:

Use only genuine parts from the manufacturer or distributor. Do not use modified parts or parts which will not give equivalent performance to the original equipment.

Tighten all screws.

Keep contact arm moving smoothly.

ASSEMBLY PROCEDURE FOR SEALS:

When repairing a tool, make sure the internal parts are clean and lubricated. Use O-Ring lubricant on all O-Rings. Coat each O-Ring with O-Ring lubricant before assembling. Use a small amount of oil on all moving surfaces and pivots. After reassembly add a few drops of Air Tool Lubricant through the air line fitting before testing.

AIR PRESSURE AND VOLUME:

Air volume is as important as air pressure. The air volume supplied to the tool may be inadequate because of undersize fittings and hoses, or from the effects of dirt and water in the system. Restricted air flow will prevent the tool from receiving an adequate volume of air, even though the pressure reading is high. The results will be slow operation, misfeeds or reduced driving power. Before evaluating tool problems for these symptoms, trace the air supply from the tool to the supply source for restrictive connectors, swivel fittings, low points containing water and anything else that would prevent full volume flow of air to the tool.

DRIVER MAINTENANCE INSTRUCTIONS

Worn driver causing poor quality or loss of power:

Wear or a chip on the driving tip will affect the nail drive, giving symptoms of bent and incompletely driven nails, and damaged nail heads.

The driver length may be adjusted to allow the driving tip to be redressed to compensate for wear. Heat and precise measurement are required. Contact a qualified service technician for this adjustment.

The length setting for a new driver is shown below. Measurement is from the bottom face of the main piston.

Note that the measurement from the top of the piston gives the maximum amount the driver may be adjusted to allow redressing. Always extend the driver the minimum required to allow redressing to restore the driving end; several redressings will be possible before this maximum depth is reached.

When using optional flangeless driver, see adjustment below. Be sure to use proper preparation and installation.

Standard Length	
FCN90(B):	6.667" – 6.683" (169.35 – 169.75 mm)
FCN90LB:	7.154" – 7.169" (181.70 – 182.10 mm)
SCN90L:	7.154" – 7.169" (181.70 – 182.10 mm)
PN90:	6.756" – 6.772" (171.6 – 172.0 mm)

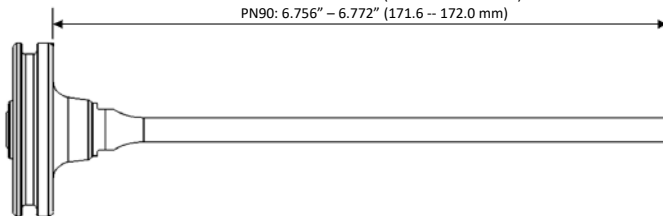

TROUBLESHOOTING / REPAIRS

The troubleshooting and / or repairs shall be carried out only by the authorized dealer / distributor or by other pneumatic tool specialists